

Features

- For GPS applications
- Usable bandwidth 2 MHz
- Very Low loss
- Single-ended operation at 50 Ω
- No impedance matching required for operation at 50 Ω
- Single-ended operation
- Ceramic Chip Scale Package (CSP)
- Hermetic
- RoHS compliant (2002/95/EC), Pb-free 

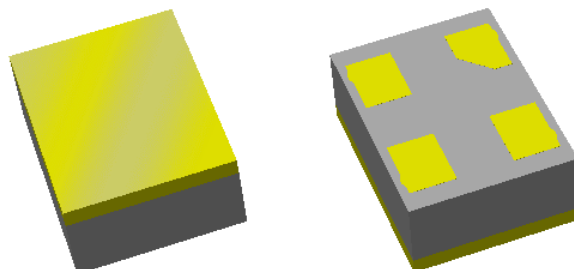

Package

Surface Mount 2.00 x 1.50 x 0.76 mm

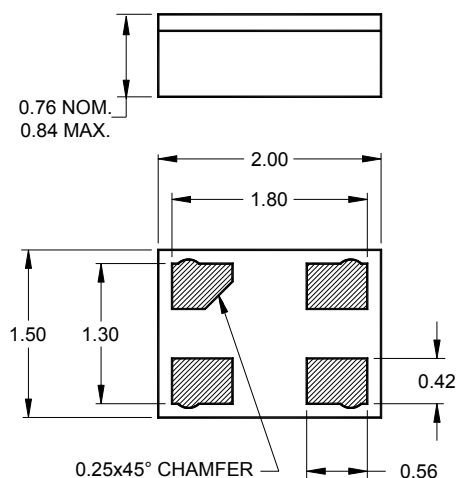

Dimensions shown are nominal in millimeters
All tolerances are ±0.10mm

Body: Al_2O_3 ceramic
Lid: Kovar or Alloy 42, Au over Ni plated
Terminations: Au plating 0.5 - 1.0μm,
over a 2 - 6μm Ni plating

Pin Configuration

Bottom View

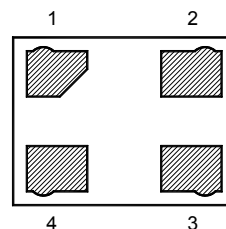

Pin No.	Description
1	Input
3	Output
2,4	Case ground

Electrical Specifications ⁽¹⁾

Operating Temperature Range: ⁽²⁾ -40 to +85 °C

Parameter ⁽³⁾	Minimum	Typical	Maximum	Unit
Center Frequency	-	1575.42	-	MHz
Insertion Loss 1574.42 - 1576.42 MHz	-	1.25	1.6	dB
Absolute Attenuation				
0 - 1475 MHz	30	36	-	dB
1475 - 1527.42 MHz	30	33	-	dB
1623.42 - 1750 MHz	30	37	-	dB
1750 - 1800 MHz	32	36	-	dB
1800 - 1990 MHz	32	38	-	dB
1990 - 3000 MHz	30	40	-	dB
3000 - 4000 MHz	20	25	-	dB
4000 - 6000 MHz	15	17	-	dB
Passband Variation 1574.42 - 1576.42 MHz	-	0.25	0.5	dB p-p
Input/Output Return Loss 1574.42 - 1576.42 MHz	10	18	-	dB
Source Impedance ⁽⁴⁾	-	50		Ω
Load Impedance ⁽⁴⁾	-	50		Ω

Notes:

1. All specifications are based on the test circuit shown below
2. In production, devices will be tested at room temperature to a guardbanded specification to ensure electrical compliance over temperature
3. Electrical margin has been built into the design to account for the variations due to temperature drift and manufacturing tolerances
4. This is the optimum impedance in order to achieve the performance shown

Test Circuit:

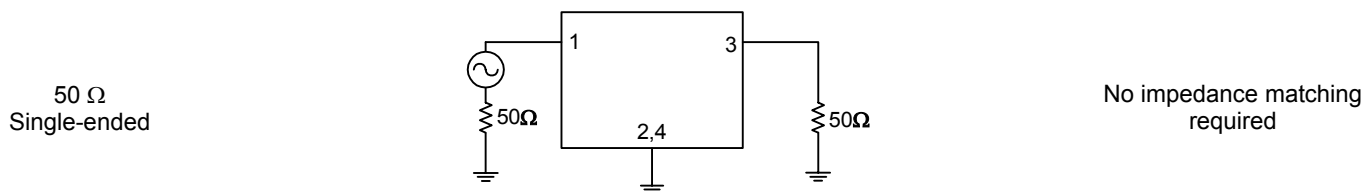

Typical Performance (at +25°C)

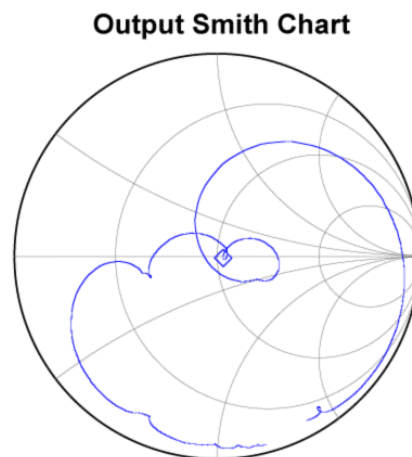
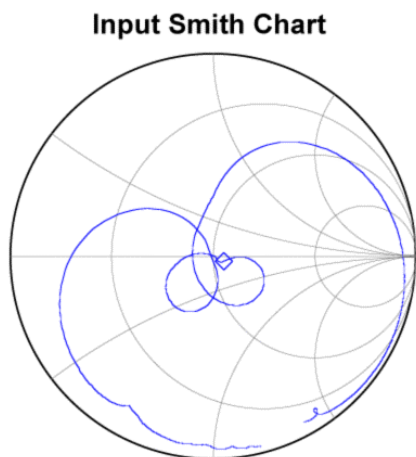
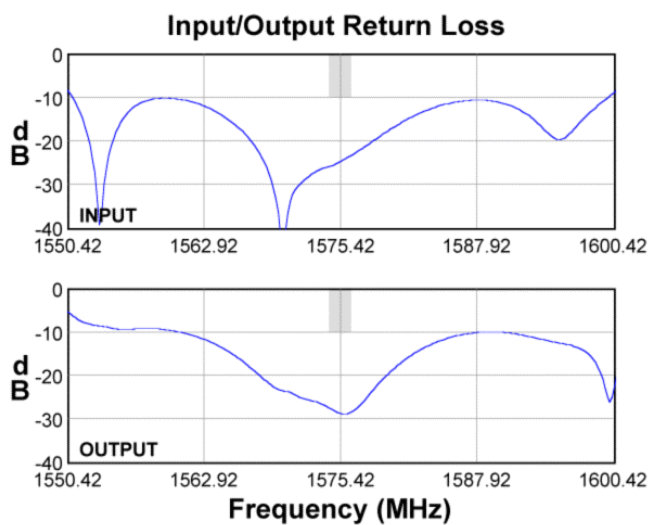
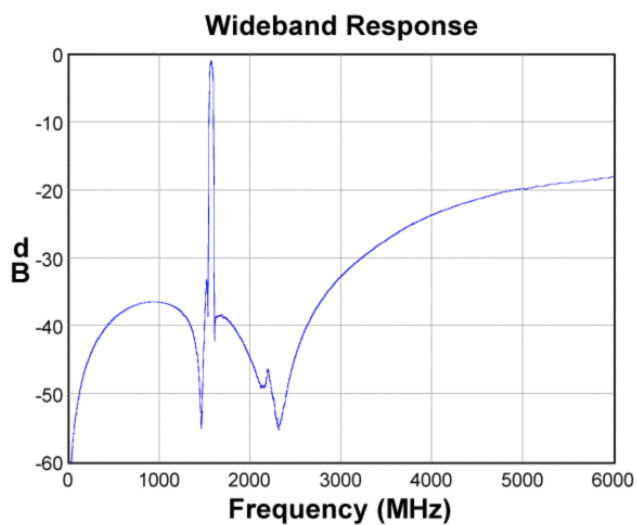
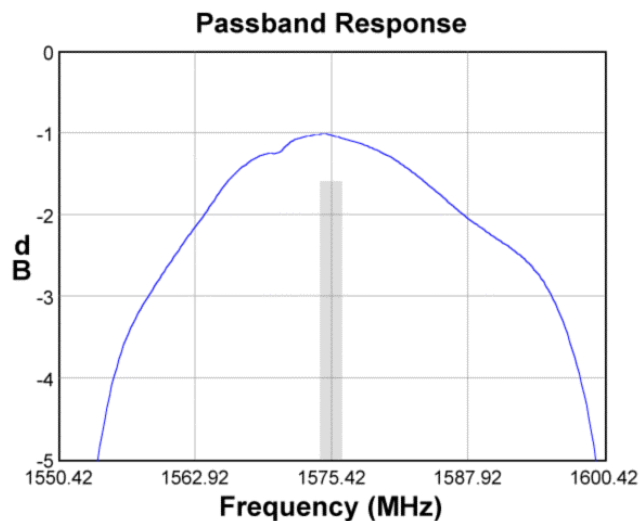
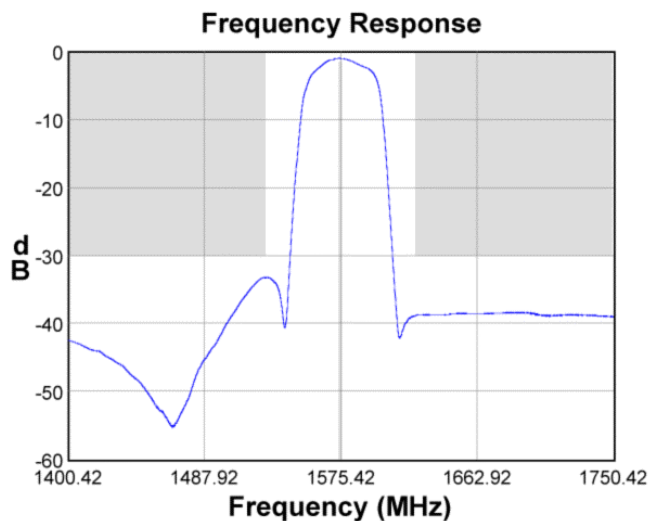

Matching Schematics

50 Ω
Single-ended

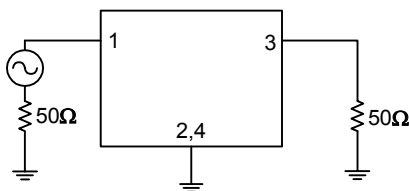

No impedance matching required

Marking

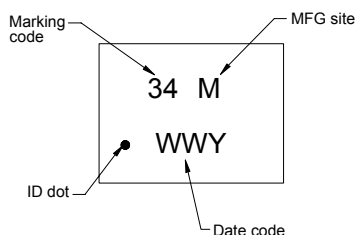

The date code consists of: WW = 2 digit week,
Y = last digit of year, M = manufacturing site code

PCB Footprint

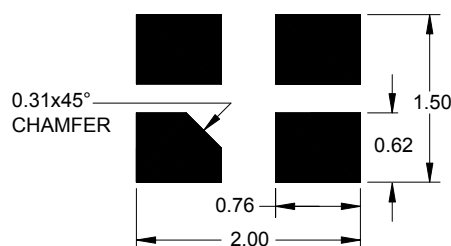

This footprint represents a recommendation only
Dimensions shown are nominal in millimeters

Tape and Reel

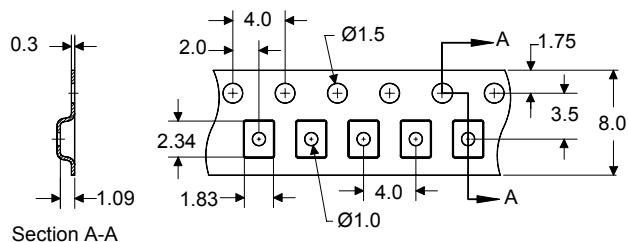
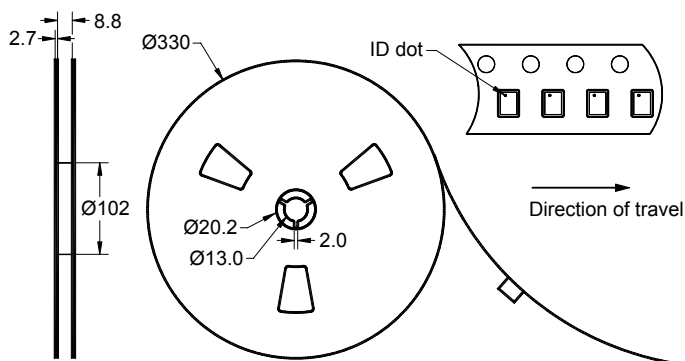

Dimensions shown are nominal in millimeters
Packaging quantity: 10000 units/reel

Data Sheet

Maximum Ratings

Parameter	Symbol	Minimum	Maximum	Unit
Operating Temperature Range	T	-40	+85	°C
Storage Temperature Range	T _{stg}	-40	+85	°C

Important Notes

Warnings

- Electrostatic Sensitive Device (ESD)
- Avoid ultrasonic exposure



RoHS Compliance

- This product complies with EU directive 2002/95/EC (RoHS)



Solderability

- Compatible with JEDEC J-STD-020C **Pb-free** process, **260°C** peak reflow temperature ([see soldering profile](#))

Links to Additional Technical Information

[PCB Layout Tips](#)

[Qualification Flowchart](#)

[Soldering Profile](#)

[S-Parameters](#)

[RoHS Information](#)

[Other Technical Information](#)

TriQuint's liability is limited only to the Surface Acoustic Wave (SAW) component(s) described in this data sheet. TriQuint does not accept any liability for applications, processes, circuits or assemblies, which are implemented using any TriQuint component described in this data sheet.

Contact Information



PO Box 609501
Orlando, FL 32860-9501
USA

Phone: +1 (407) 886-8860
Fax: +1 (407) 886-7061
Email: info-product@tqs.com
Web: www.triquint.com

Or contact one of our worldwide
Network of [sales offices](#),
[Representatives or distributors](#)